

## AFTERCARE INSTRUCTIONS

Excessive exposure to water will deteriorate the furniture. Wipe away any water splashes or condensation after use.

All bathrooms should be well ventilated. If necessary we recommend the installation of a suitable extractor fan.

Clean with a soft damp cloth only.

Use a wax free polish if one must be used.

All electrical components are IP44 rated.

Do not allow water to come into contact with the electrical components.

## CUSTOMER SERVICE

t: +44(0)208 686 5100  
e: [technical@saneux.com](mailto:technical@saneux.com)

4 Imperial Way  
Croydon CR0 4RR

[www.saneux.com](http://www.saneux.com)

# HYDE

## INSTALLATION INSTRUCTIONS

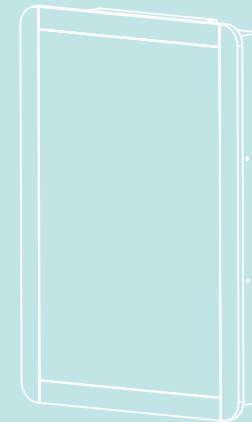

HY055EC

saneux

**NOTE:** Handle with care! When unpacked, never place upright on a hard surface. Always lay on soft surface.

**IMPORTANT**

- Unless otherwise stated, throughout the entirety of the installation process, make sure that the domestic electrical mains supply to which the product is being connected is turned off.
- The fixings supplied are for solid walls. For hollow or stud walls use specialist fixings.
- Before drilling ensure that there are no hidden cables or pipes in the wall.
- This product has special protection against the ingress of moisture and is manufactured to meet IP44 standards.

**COMPONENTS**

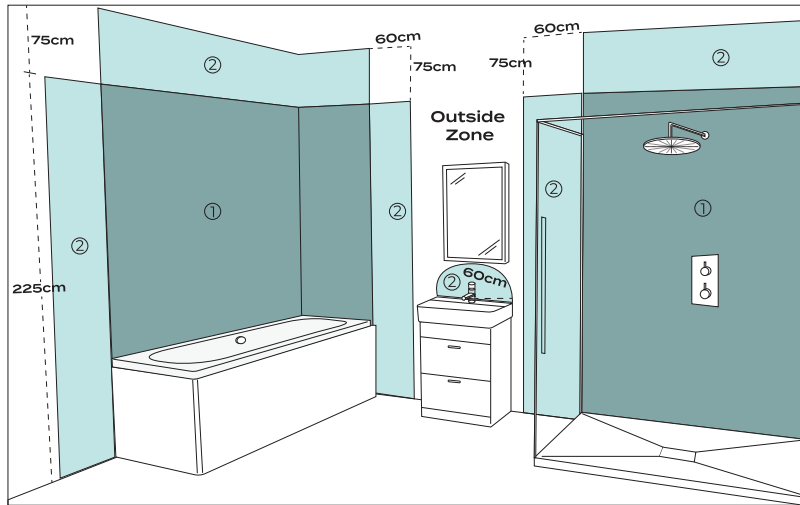
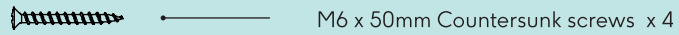

All electrical bathroom products should be fitted by a qualified electrician.

This product is only suitable for the 'Outside zone' indicated in the image above.

**WIRING DIAGRAM**

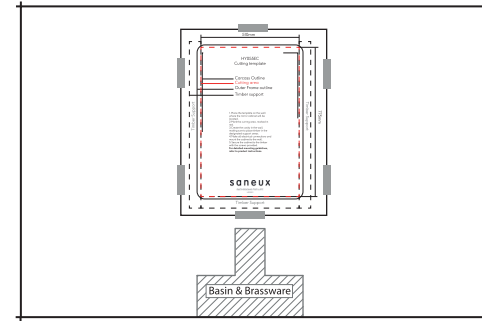
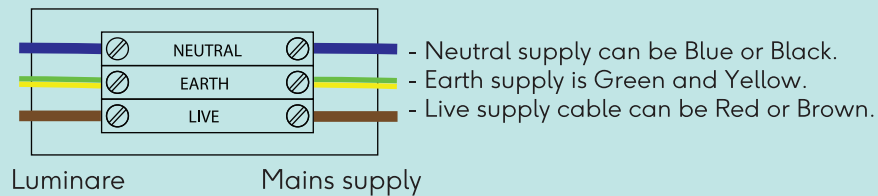

Firstly, fix the cutting template provided with the cabinet onto the stud wall, in the location intended for the cabinet. Make sure that it is level and that there is enough space for the basin and brassware beneath, before carefully cutting around the dotted line labelled 'cutting area'. Ensure you are wearing the correct PPE.

Build in the studding around the inside of the cutout in the wall, refer to the cutting template for the locations.

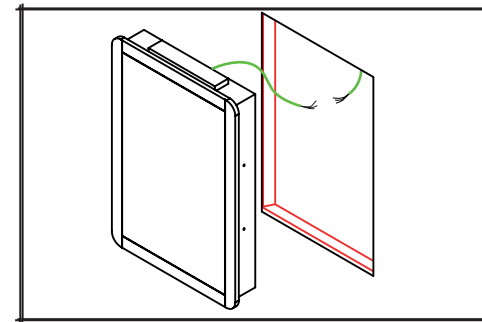
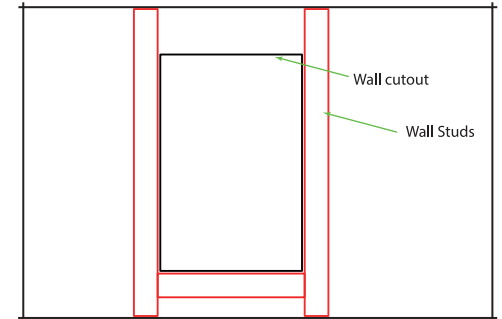

Offer the cabinet up to the recess and make the electrical connections, referring to the wiring diagram on page 2. Finish placing the cabinet into the recess, resting on the horizontal studding to bear the weight.

From the inside of the unit, use the supplied screws to secure the cabinet within the recess. Ensure the frame is flush with the wall.

